



moveLOC

I N D E X E D



Manual

Thanks for buying the moveLOC dropper post.

You have purchased a product, which is designed, manufactured, assembled and tested in Germany.

A dropper post is a highly stressed moving part on a mountain bike, which is direct exposed to dirt. These facts make periodic maintenance for the post necessary. During the design process, we had a big priority regarding minimum maintenance, durability and easy servicing. As a result of this, you can do all servicing with a standard mini tool.

Please read the manual carefully, before installing your moveLOC dropper post at your bike..

Add. information you can find on our website
<http://vecnum.com/en/products/moveloc/servicefaq/>

There will be always the latest version of the manual online.

For a quick an easy installation you will also find a video tutorial on this website.

Intended use:

The moveLOC dropper post is designed for mountain bikes and their purposes.

The installation on a road bike is also permitted

The moveLOC dropper post can handle a max. rider weight of 120 kg.

Installation dimensions:

You can easily find the suitable length for your moveLOC dropper post by our online CONFIGURATOR:

<http://vecnum.com/en/products/moveloc/configurator>

The moveLOC dropper post is only manufactured with diameter 30,9 mm. To adapt the post to several seat tube diameters, we offer different shims in our online shop. This standard diameter saves weight and assures a maximum of flexibility using other seat tube diameters in the future.

Operation instructions:

Please make sure, that you are fully familiar with the function of the moveLOC dropper post before your first ride. Due to an operating error you can loose control of your bike, which can occur an fatal accident.

After a short period of familiarisation, you will shift your moveLOC dropper post intuitively to the individual height positions. Please exercise the handling at an easy trail. The moveLOC can be indexed at 4 different height positions, which enables a fast and repeatable height adjustment.



Don't lower your dropper post completely when using a cable lift (max. position 3), because the T - bar can damage the shaft sealing unit.

For cleaning the bike you must completely lower the dropper post.

Installation:



For all installation and maintenance on the dropper post:

Push Fail-Safe button and completely extend dropper post

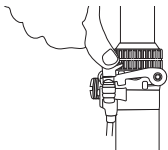

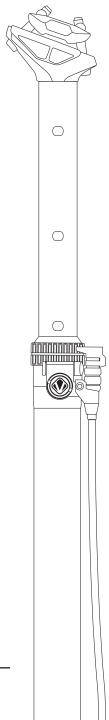

Position 1 :

pedalling (maximum position = post completely extended)

The maximum positions should be adjusted in a way, that allows an ergonomic position for pedalling uphill

Position 2 :

trail (40mm lowered referred to maximum position)

This Position is ideal for riding easy trail incl. pedalling section. With 40mm lowering you will have significant more ability to move with the bike. Moreover this, you have the possibility for pedalling on saddle with a reasonable effectiveness for climbing technical uphill.

Position 3:

Downhill (100 or 90 mm lowered referred to max. Position)

This position is intended for fast downhill sections. With the feedback of the saddle you can guide your bike precisely.

Position 4:

technical downhill (saddle maximum lowered)

Maximal freedom for movement on the bike for steep sections, trial skills etc.

CONTENT

- 1 - Installation preparation**
- 2 - Installation dropper post and saddle**
- 3 - Installation remote lever and cable housing**
- 4 - Bowden cable installation / replacement and adjustment**
- 5 - Easy maintenance and care**
- 6 - Trouble shooting and maintenance**
- 7 - Guarantee and Warranty**



2.5mm

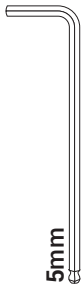

5mm

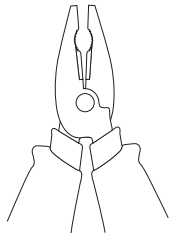

universal pliers



We can only guarantee proper function of the moveLOC dropper post by using a tooLOC seat clamp.



Comparison between a conventional seat clamp and tooLOC seat clamp

conventional seat clamp



uneven force distribution into the seat tube.
This can occur function restrictions for dropper post.

tooLOC

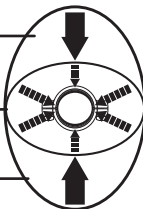

more even force distribution into the seat tube for a perfect dropper post function

1 - Montagevorbereitung

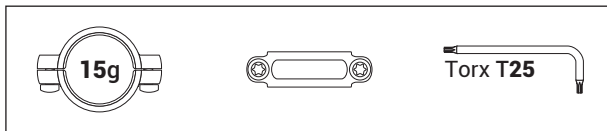

1.1 Remove old seat post clamp

1.2 Install tooLOC clamp

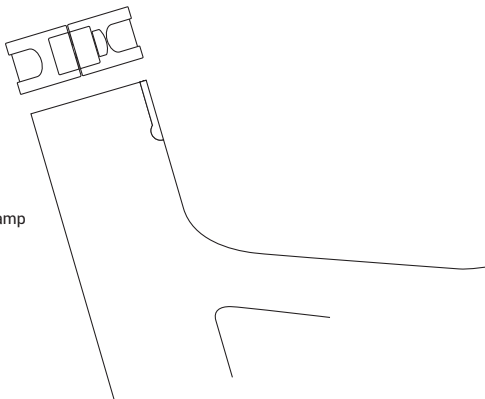

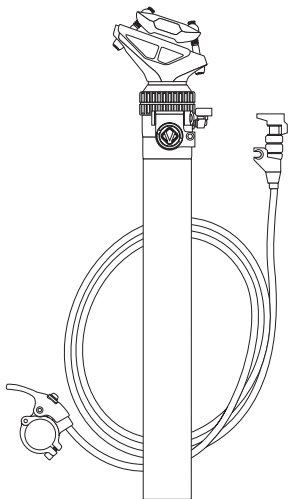

1.3 Clip in the cable remote at the dropper post

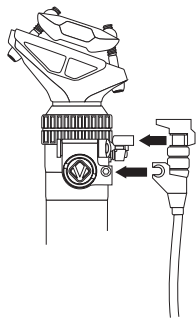

1.4

Screw the cable holder tight at the dropper post body

Allen key 2.5mm

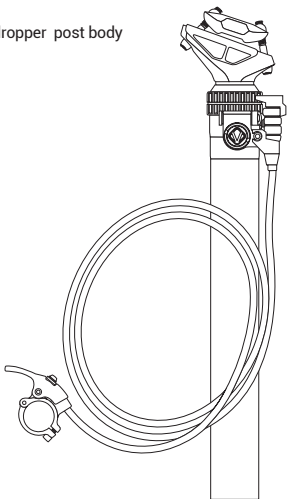
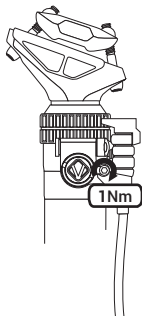

2 - Installation dropper post and saddle

2.1 Completely extend dropper post



Press Fail Safe button
and completely extend
seat post

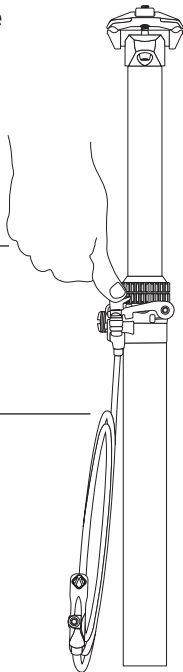

2.2 Insert dropper post into the seat tube

2.3 Tighten seat clamp

Torx T25



For an easy installation, preset the post roughly to the height position in the seat tube and tighten the seat clamp bolts hand tight

Recommendation:

Please use the supplied assembly paste for reliable clamping between post | shim | seat tube

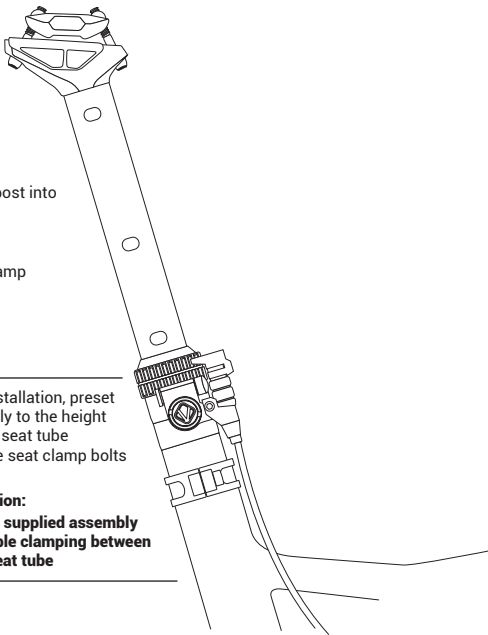

2.4 Loosen rear bolt

Allen key 5mm



2.5 Remove bolt and nut from upper rocker of the rail clamp

2.6 Put the saddle rail into the lower rocker of the rail clamp

2.7 Put the upper rocker back onto the saddle rail

2.8 Hang up the rear clamp bolt into the upper rocker

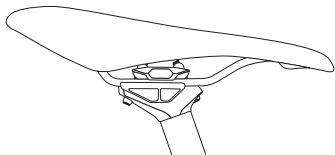
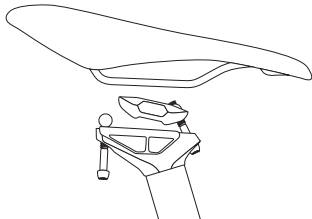

2.9 Adjust saddle position

Allen key 5mm



Adjust saddle tilting first, then horizontal position

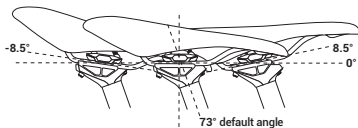

Tighten rear bolt while pressing on saddle bottom
Tighten front bolt while pressing on saddle nose

Allen key 5mm

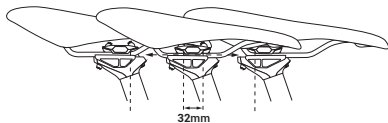

2.10 Tighten the clamp bolts alternated

Allen key 5mm

2.11 Shake saddle strongly and check the torque of the bolts again



Please check the torque of the clamping bolts after first couple of hour used.
- Note maximum torque!

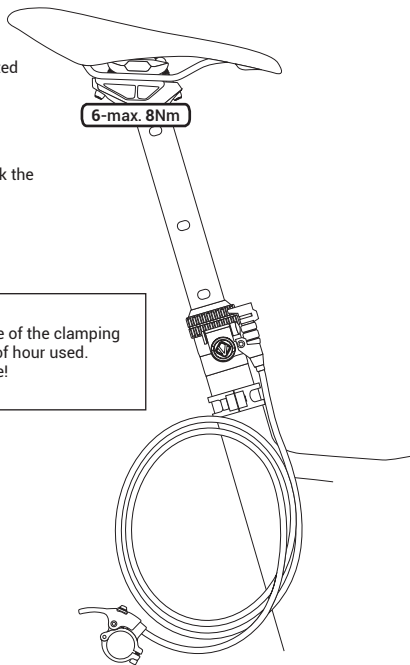



The bolts must have 6 supporting threads in the nut.
--> 6 threads (=6mm)

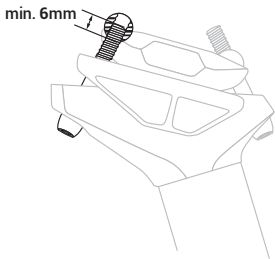

If you use a extreme tilting or a carbon saddle with high oval shaped rails, it may happen, that the standard M6x30m Titanium bolts do not require the 6mm supporting thread

In our online Shop <https://shop.vecnum.com> we offer longer bolts M6x35 for this special application

3 - Installation remote lever and cable housing

- 3.1** Loosen bolts for cable clamp on the remote lever

Allen key 2.5mm



- 3.2** Remove protective rubber cap from Fail Safe button

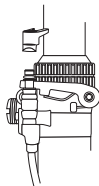

- 3.3** Pull out the remote cable from the housing half way to enable cutting the cable housing

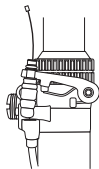

- 3.4** Remove remote lever from the cable housing





First set the bolt from top side, before you rotate the remote lever to its final position

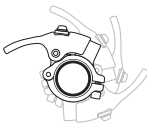

- 3.5** Adjust the position in a way that you can actuate the trigger with your thumb in the most ergonomic way

- 3.6** Tighten the clamp

Allen key 2.5mm

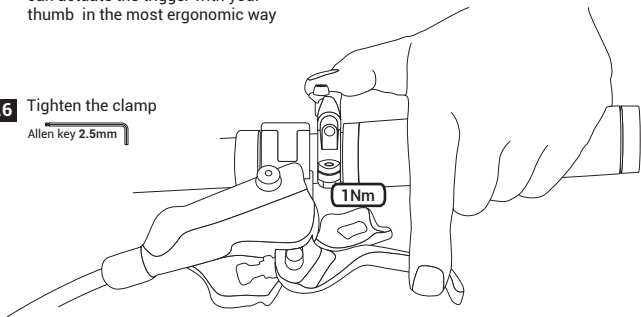

3.7 Cable routing on on the frame



If your frame offers some cable holders in or on top or down tube, you can use the recommended routing line for the cable

If there is no cable routing for dropper posts with an external actuation available, you can use our provided universal cable holder pads for installation

We recommend the routing on the top tube (A) our on the down tube (B)

If the standard bowden cable length is not long enough, you can order cable and housing in our online shop by the meter

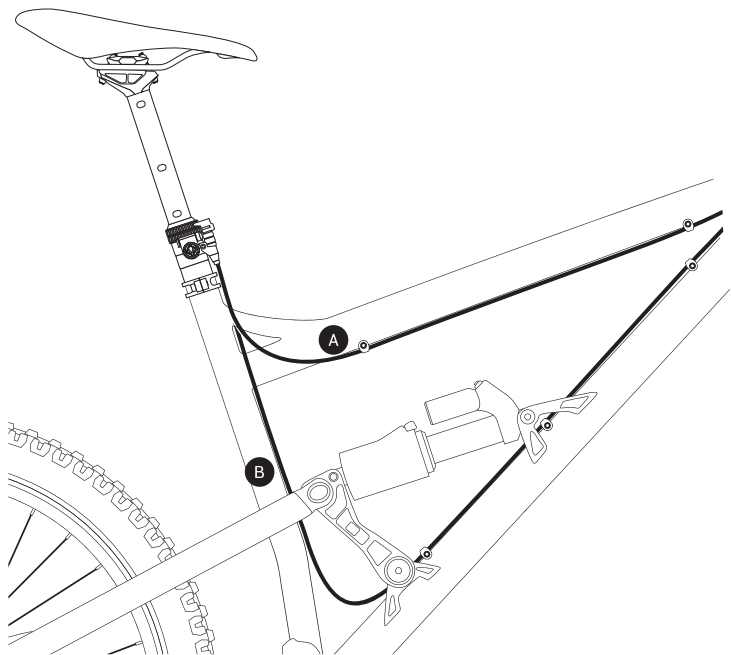

3.8 Cutting cable housing

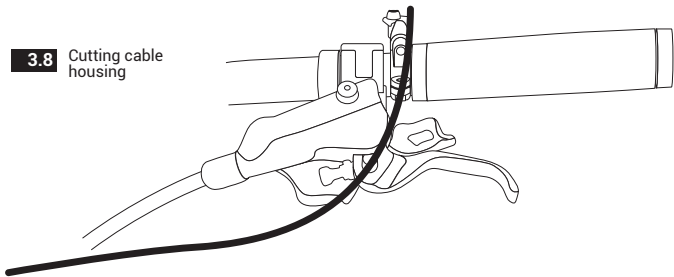

Pay attention to the steering angle

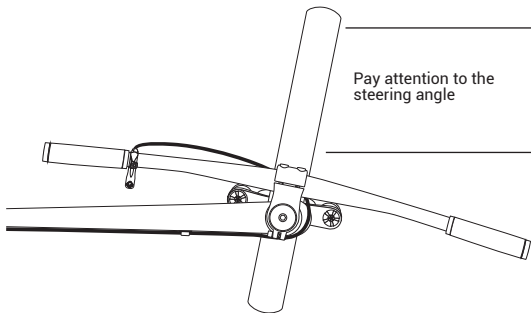

- 3.9** Cut cable housing to the intended length

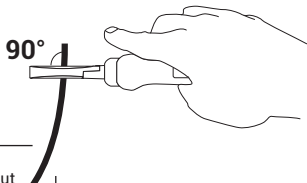

Please make sure, that you pull out the cable from the housing before cutting (see : 3.3)

- 3.10** Reform crimped cable housing

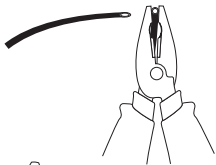

- 3.11** Insert the cable housing into the remote lever

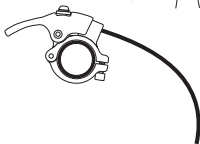

4 -Bowden cable installation / replacement and adjustment

4.1 Insert cable

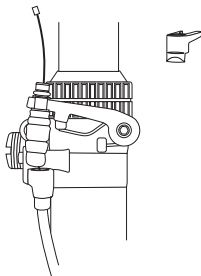

4.2 Route the cable underneath the clamping plate to the insert of the cable channel from the trigger. Support the routing by moving the clamping plate.



Push back the trigger to home position, that the cable appears on the lower end of the trigger.

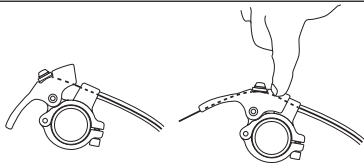

- 4.3** Tighten the cable with the universal pliers until the Fail Safe button moves to end position.

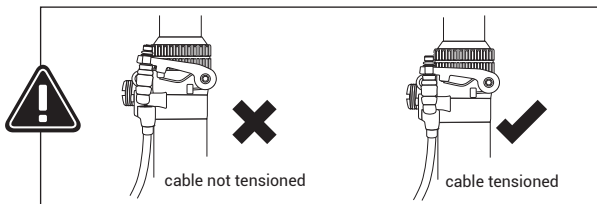
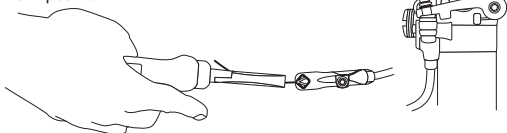

- 4.4** Clamp cable

Allen key 2.5mm

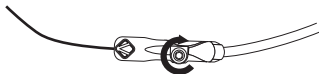

- 4.5** Put on protective rubber cap to the fail safe button

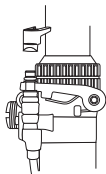

Press remote control a few times to check tension of the cable.

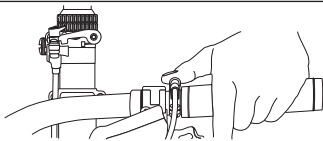

- 4.6** Loosen the cable clamp again

Allen key 2.5mm

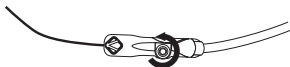

- 4.7** For hiding the cable end in the trigger you have to press the Fail Safe button to cut off the cable even on the trigger

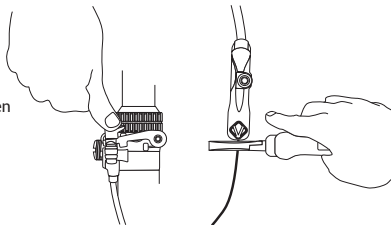

- 4.8** Release the Fail Safe button carefully

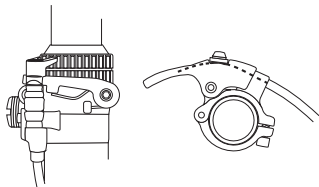

Cable will be returned further by spring.
If you release the Fail Safe button suddenly, this can
lead to an unwanted free travel.

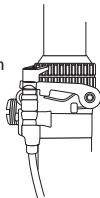

- 4.9** Tighten cable clamp

Allen key 2.5mm

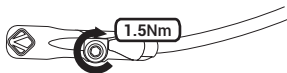

4.10 Function test

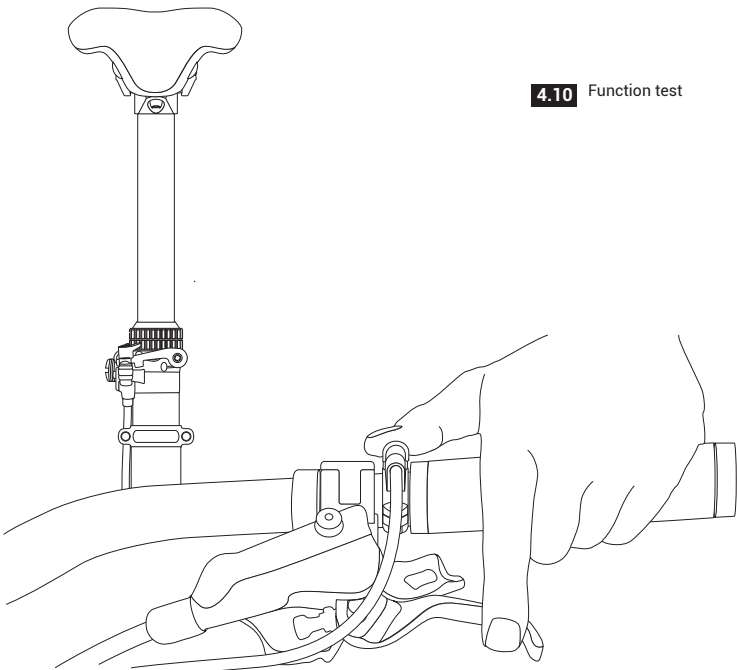

4.11 Attach cable housing most suitably

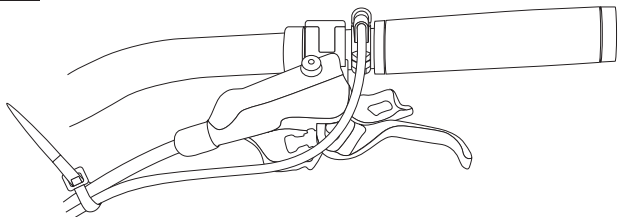

5 - Easy maintenance and care



Before riding, you have to check the dropper post regarding damages. For cleaning the bike you must completely lower the dropper post. We recommend resin free oil with low viscosity for lubrication of the upper sealing unit.

Our advice: Dynamic Kettenschmierstoff
(available in many German bike online stores)

- 5.1** For a long term reliability of your moveLOC dropper post we recommend a relubrication of the foam ring at the upper sealing unit at least after 3 month. If you are running the post in dusty or muddy environment a re-lubrication after 1.5 month is helpful.
This easy maintenance can be done with a tire lever within a few seconds.

- 5.2** Remove upper seal ring with a tire lever

- 5.3** Push up the seal ring from the sealing unit

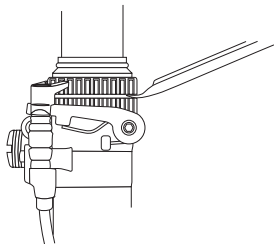

5.4 Put oil onto the foam ring

Our recommendation:
resin free oil with a low viscosity

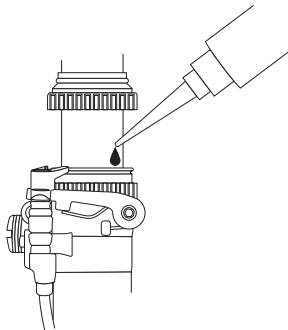

5.5 Slide back the upper sealing ring to the seal unit until it engages

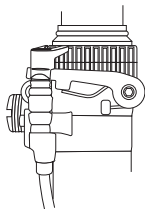

6 - Trouble shooting and maintenance



If you have any problem with the function/handling, please first visit our website regarding an update in FAQ / manual

<http://vecnum.com/en/products/moveloc/servicefaq>

On this site you will find updated manuals, Video tutorials for maintenance, etc.

7 - Guarantee and Warranty

7.1 Guarantee

The Vecnum GmbH grants a warranty of two years, as required by law.

Wearing from using the products is not covered by warranty.

As all moving parts on the bike, also the moveLOC dropper post needs the recommended maintenance and will show wear.

The service intervals / durability depends on operating conditions.

Sealings, bushings and glide surfaces are subject to a wear.

Furthermore the guarantee does not cover damages caused by improper or other than the intended use, damages caused by crashes or installation faults as well as improper maintenance.

Notice:



Vecnum GmbH
Alte Bahnlinie 25
88299 Leutkirch
Germany

Communication
Phone +49(0)7567.182882
info@vecnum.com
www.vecnum.com

06-2017