

levelLOC

Manual

Thank you for buying the levelLOC fork travel adjuster!

You chose a high-quality product, designed and manufactured in Germany.

The levelLOC fork travel adjuster is (in combination with the Syntace Megaforce 2 stem) subjected to high forces. Therefore we urge you to regularly check all critical parts (stem, screws, clamps etc.) for faultless function. If damages are visible, please replace the respective parts.

We tested the levelLOC travel for adjuster on many available mountainbike forks, without facing any troubles. However, we cannot assume liability for any damages which occur by using the levelLOC on your fork.

Please carefully read this manual before installing the levelLOC fork travel adjuster on your bike.

You can find additional and latest information about the levelLOC on our web page <https://www.vecnum.com/en/products/levelloc/servicefaq>

To assist you with installing the levelLOC on your bike, we provide a video tutorial on our web page, showing the procedure step-by-step.

Intended use:

The levelLOC fork travel adjuster was designed for use on mountainbikes. The levelLOC may only be used with forks with a front-facing, single crown.



Handling:

Please get used to the working principle of the levelLOC before the first ride. Miss-use of the levelLOC might lead to loss of control and therefore to crashes harming you and your bike.

Adjusting the travel will be easy for you after a few trials. Please get used to the handling of the levelLoc before you start your ride.

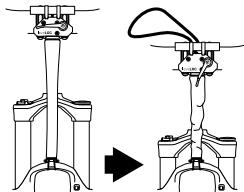

The levelLOC allows you to quickly reduce the travel of most forks by up to 80 %.

Lowering the fork travel leads to a steepening of the seat-tube angle, and therefore to an ideal position on the bike for pedalling uphill.

Additionally, reducing the fork travel leads to a more compact bike for easy pushing and carrying uphill.

The smaller dimensions of a bike with reduced fork travel further facilitate transportation in the luggage compartment of your car.

There's no need for removing the levelLOC when going downhill, as the levelLOC does not affect the function of your fork when uncompressed. However, the quick-mount interface allows you to remove the levelLOC in no time (useful for instance when visiting a bike park).

Scope of supply

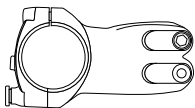

Syntace Megaforce 2



Cable strap



Protective foil for the fork

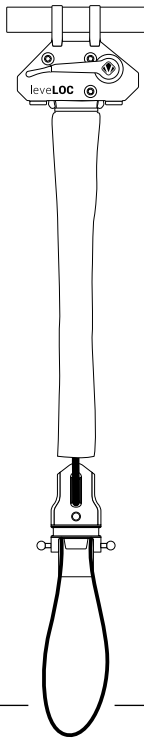

CONTENT

- 1 - Mounting the stem**
- 2 - Attaching the levelLOC to the fork**
- 3 - Attaching the levelLOC to the stem**
- 4 - Adjusting the levelLOC rope**
- 5 - Fitting the neoprene tube**
- 6 - Lever positions**
- 7 - Lowering fork travel**
- 8 - releasing the levelLOC**
- 9 - removing the levelLOC from the stem**
- 10 - Troubleshooting and service**
- 11 - Warranty**



2.5mm



5mm

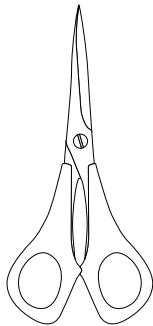

Scissors

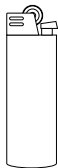

Lighter

1 - Mounting the stem

- 1.1** Check the excess length of your fork shaft starting at the upper end of the headset, or at any spacers, if used. **30mm** excess length are required for safely clamping the stem.*

Inbus 5mm

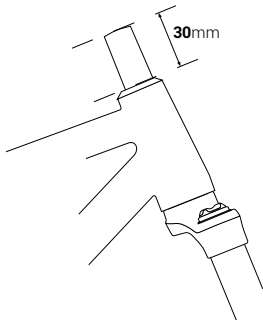

Attention: The top headset screw is an adjustment screw for tuning the play of the bearings! Torque the screw (while keeping the stem clamping screws loose) only so much that there's no play in the headset bearings when moving your bike back and forth while braking at front. The fork must still be able to easily rotate. Please consider the manual of your bike for further details.*

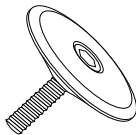

- 1.2** Tighten the clamping screws alternatingly up to max. **8Nm** using a torque wrench.

Inbus 5mm

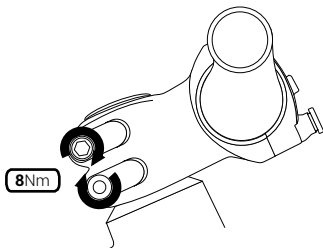

If you use a carbon shaft: Please check with your fork manufacturer if your fork allows the above mentioned torque. If no, please initially tighten the clamping screws to **4Nm** and check if your stem is safely clamped.*

Our recommendation when using carbon shafts: Syntace friction paste

1.3 insert screws as depicted.

Inbus 5mm

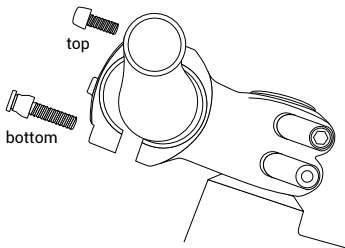

First, tighten the bottom screws completely (8Nm), Then continue tightening the top screws (8Nm).

At the top there must be a slit, whereas at the bottom there must be none.

If you use carbon handlebars, consider the recommended torque by the manufacturer.

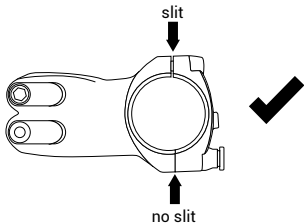

1.4 Clamp the handlebar

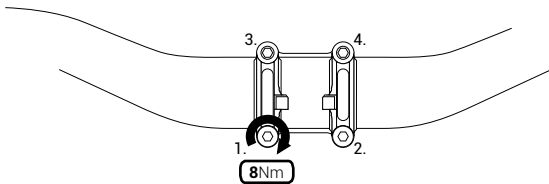

Attention: Fix the frontwheel with your legs and knees and try rotating the handlebar for checking if the stem is mounted correctly (without being able to rotate around the shaft of the fork). If necessary increase the torque in increments of **0.5Nm** until the maximum allowed torque is reached. Never exceed the allowed torque.*

2 - Attaching the levelLOC to the fork



Attention: For mitigating damages to the finish of your fork we recommend to apply protective foil to the center of your fork crown.

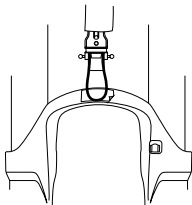

- 2.1** The clamping screw head and the seal of the neoprene tube must face backwards.

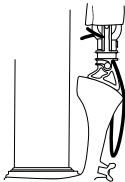

- 2.2** Hook the rope to the left end side of the horizontal bar.

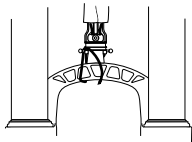

- 2.3** Guide the rope through the notch to the right hand side and hook it to the horizontal bar.

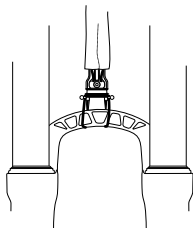

For easy handling, the horizontal bar can be moved.

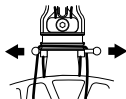

- 2.4** Loosen the clamping screw.

Inbus 2.5mm

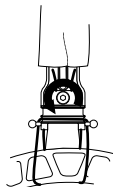

- 2.5** Adjust the length of the bottom rope so that the rope encloses the fork crown, with the elastomer being strongly pressed to the crown.

- 2.6** Do this by pulling both ends of the rope while pushing down the elastomer.

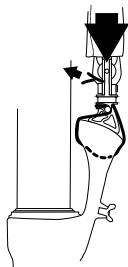

- 2.7** If done correctly, the elastomer sits tightly on the fork crown, but it is still possible to remove the rope from the horizontal bar.

- 2.8** When the correct configuration is found, tighten the clamping screw (2Nm).

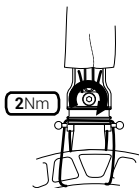

Inbus 2.5mm



Attention: After mounting the levelLOC please make use of it a couple of times, as the rope might lengthen after first use. If necessary re-adjust the length of the rope before attaching the neoprene tube.



The elastomer must not lift from the fork crown when the fork travel is reduced!

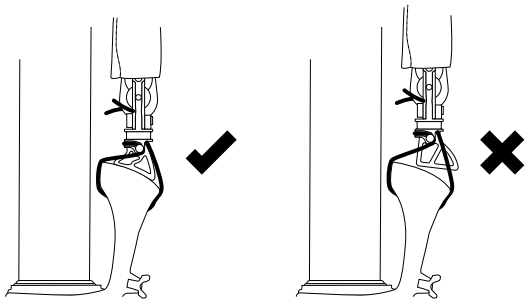

3 -Attaching the levelLOC to the stem

- 3.1** Attach the levelLOC by pushing it down until it snaps to the bottom screws of the stem. The guiding blocks of the levelLOC must sit behind the special fixture of the stem.

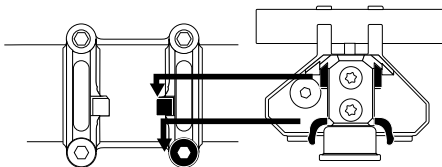

Attention: Hold the levelLOC parallel to the stem when pushing down. Unparallel alignment might lead to tilting an incorrect mounting.

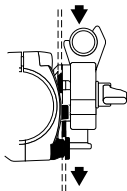

- 3.3** You should hear a loud click noise when the levelLOC snapped to the bottom screws.

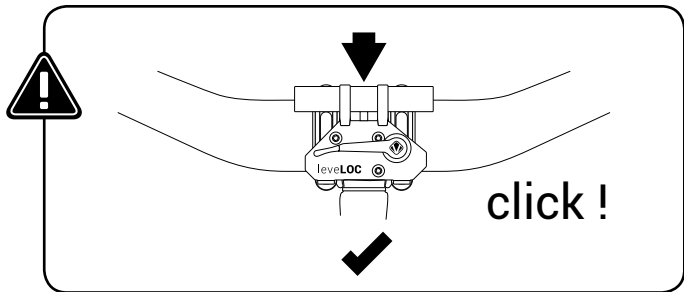
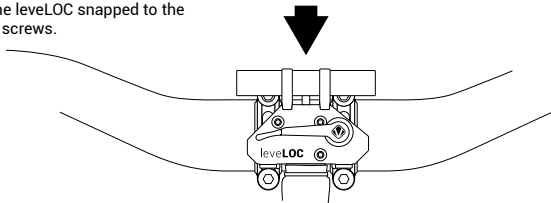

4 -Adjust the levelLOC rope

- 4.1** Pull the rope from the locking handle, bring the rope to tight tension, and lock the handle.

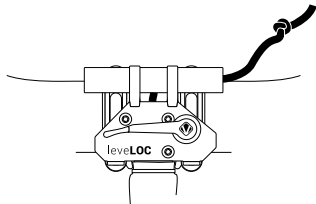

- 4.2** Loosen the knot and move it as close to the locking handle as possible.

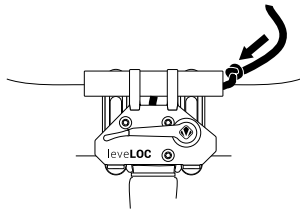

- 4.3** Cut the loose end. (There should be an excess length of 3cm)

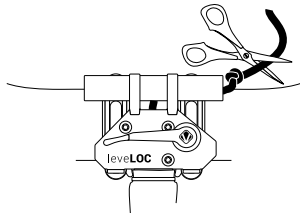



Attention: Please create an additional end stop to the rope by melting its end. This ensures increased user safety, as it becomes more unlikely for the user to unplug the rope completely.

For doing so, please melt the end of the rope, and push it against a flat surface to create a mushroom-shaped end stop.

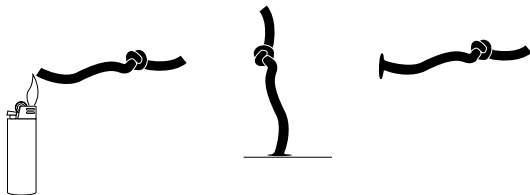

5 - Fitting the neoprene tube

- 5.1** Shorten the neoprene tube to be **30mm** shorter than the levelOC.

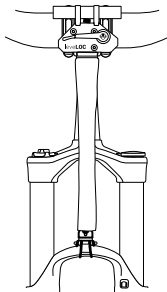

- 5.2** Remove the excess tube carefully with a scissor.

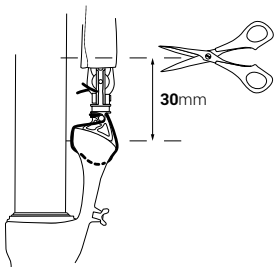

- 5.3** Put the end of the bottom rope inside of the neoprene tube, and fix the neoprene tube to the notch by using a cable strap.

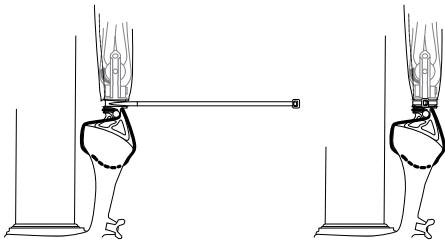

Attention: Fixing the neoprene tube is more easy as the fork travel is reduced by using the levelOC. Please keep in mind to fix the neoprene tube with the seal facing backwards.

6 - Lever positions

Position 1

levelLOC is open, no adjustment of fork travel

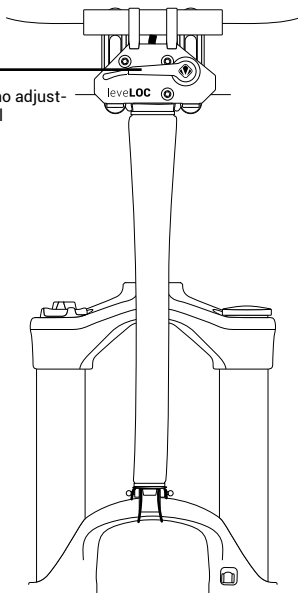

Position 2

levelLOC is active,
Adjustment of travel of up to
80% by pulling the rope.

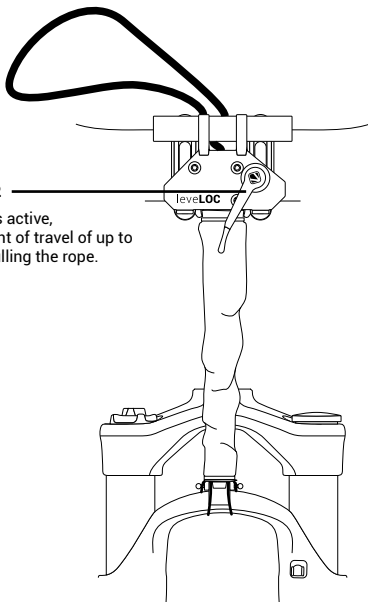

7 - Lowering fork travel

7.1 Bring the lever to position 2

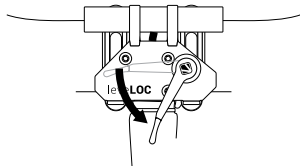

7.2 Push the fork down and pull the levelLOC rope.

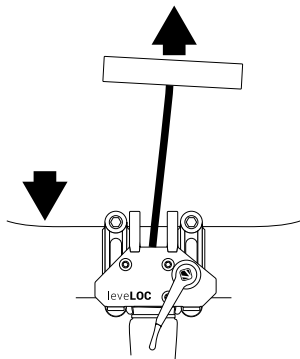

- 7.3** Reattach the locking handle after using the levelLOC.

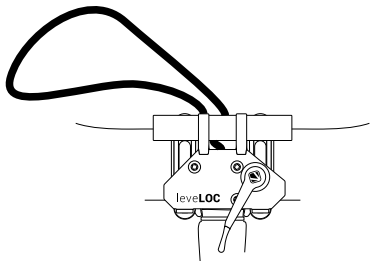

Please make sure that the rope can easily move back after the levelLOC is being released.

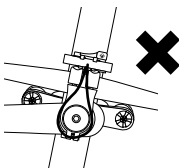
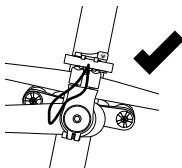

Take special care of top-mounted spacers, navigation devices, etc.

8 - Releasing the levelLOC

8.1 Bring the lever to position 1

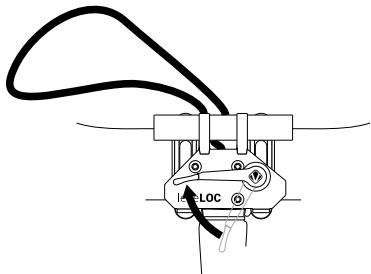

8.2 Compress the fork by pushing down with both hands at the grips.

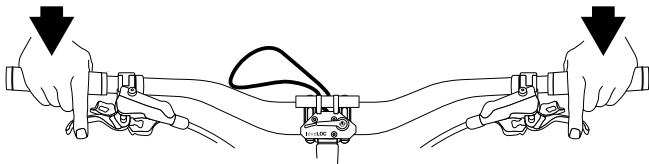

- 8.3** The fork is now at full travel and the rope is hidden inside of the levelOC.

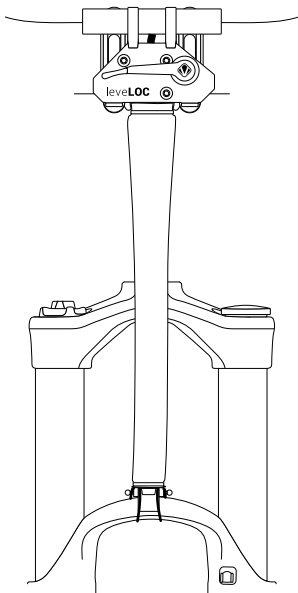

9 - Removing the levelLOC from the stem



The levelLOC must be released.

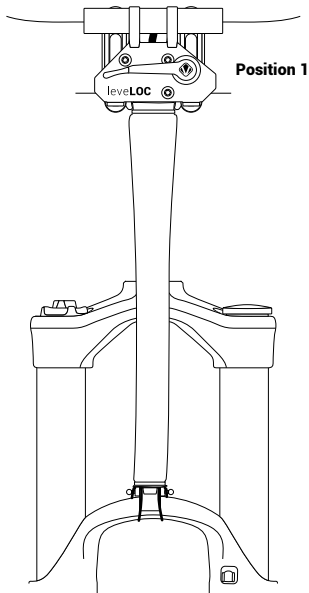

9.1 Pull the levelLOC sky facing.

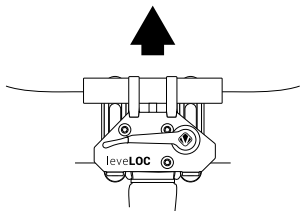

9.2 Move the horizontal bar in any direction.

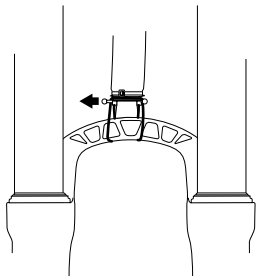

- 9.3** Push down the elastomer and release the bottom rope at the short end of the horizontal bar.

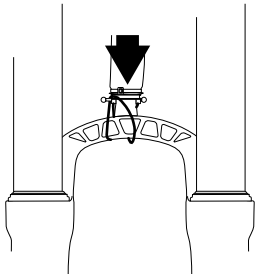

- 9.4** Move back the horizontal bar and release the rope at the other side.

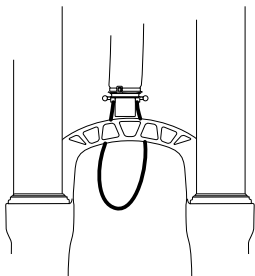

10 - Troubleshooting and service



In case of any problems with the function, the installation or the use of the levelOC, please consult our web page: <https://www.vecnum.com/en/products/leveloc/servicefaq>

There you can find various tutorials on how to install and use the levelOC, which might immediately solve your problem.

11 - Warranty

11.1 Warranty

The Vecnum GmbH guarantees a compulsory 2-year warranty for the levelLOC fork travel adjuster. Wear due to normal use is not subjected to warranty. As any other moving parts on your bicycle, the levelLOC is in need for service and maintenance.

The life-time of the levelLOC strongly depends on the circumstances of use. Especially all ropes and tubes of the levelLOC should be regularly checked for damages.

The warranty does not apply in case of abnormal use, damages related to crashes, damages related to wrong installation, or improper maintenance.

Notes:



Vecnum GmbH
Alte Bahnlinie 25
88299 Leutkirch
Germany

Contact
Telephone ++49(0)7567.182882
info@vecnum.com
www.vecnum.com